

FINITIONS FAÇADES | ACABADOS PUERTAS

PET MAT | PET MATE

FAÇADES MATES
PUERTAS MATE

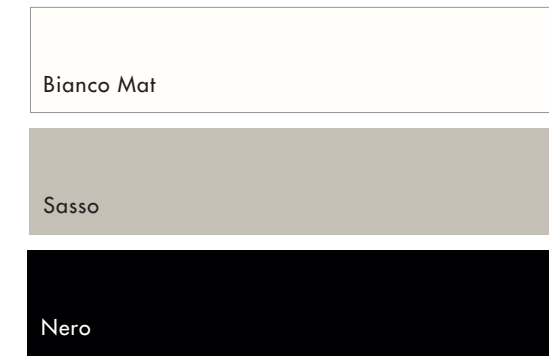

PET BRILLANT | PET BRILLO

FAÇADES BRILLANTES
PUERTAS BRILLOS



MONOLAQUE MAT | MONOLACADO MATE

FAÇADES MATES
PUERTAS MATE

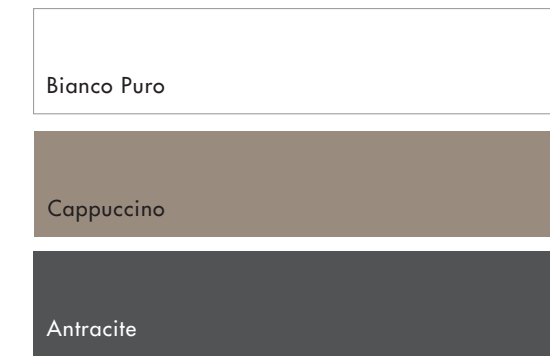

MONOLAQUE BRILLANT | MONOLACADO BRILLO

FAÇADES BRILLANTES
PUERTAS BRILLOS



MODULARIDAD | MODULARITÉ

ÉLÉMENTS BAS ET ÉLÉMENTS HAUTS
MUEBLES BAJOS Y MUEBLES COLGANTES

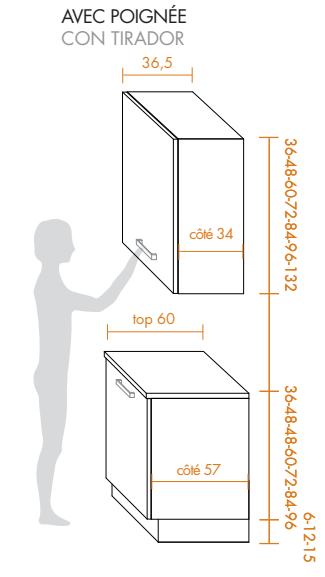
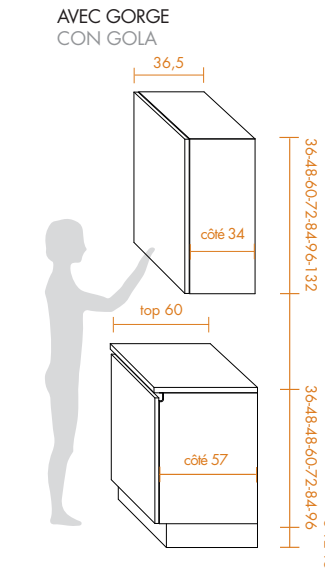

COLONNES
COLUMNAS

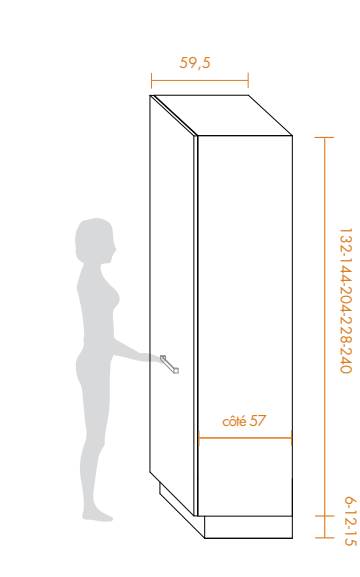

COMBINAISONS DE HAUTEUR ENTRE MUEBLES HAUT ET ARMOIRES
COMBINACIONES DE ALTURA ENTRE MUEBLES COLGANTE Y COLUMNAS

ARMOIRES ET MUEBLES HAUT AVEC PIEDS H.12-15 | COLUMNAS Y MUEBLES COLGANTE CON PATAS H.12-15

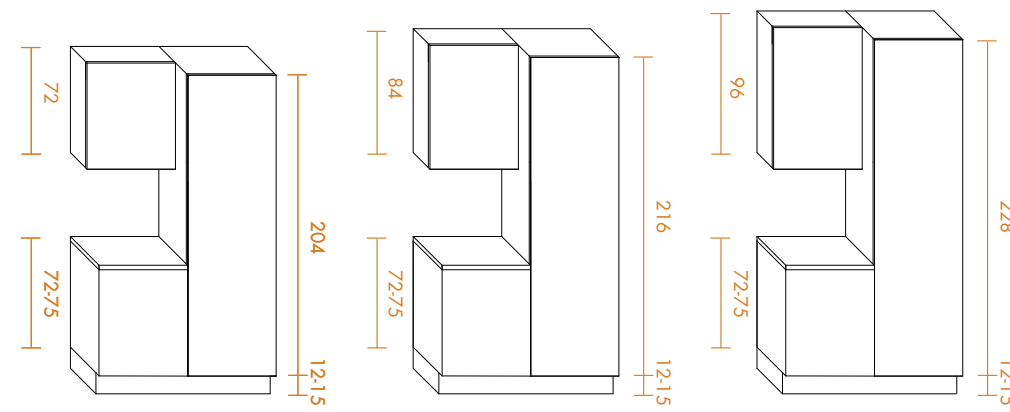

ARMOIRES ET MUEBLES HAUT AVEC PIEDS H.6 | COLUMNAS Y MUEBLES COLGANTE CON PATAS H.6

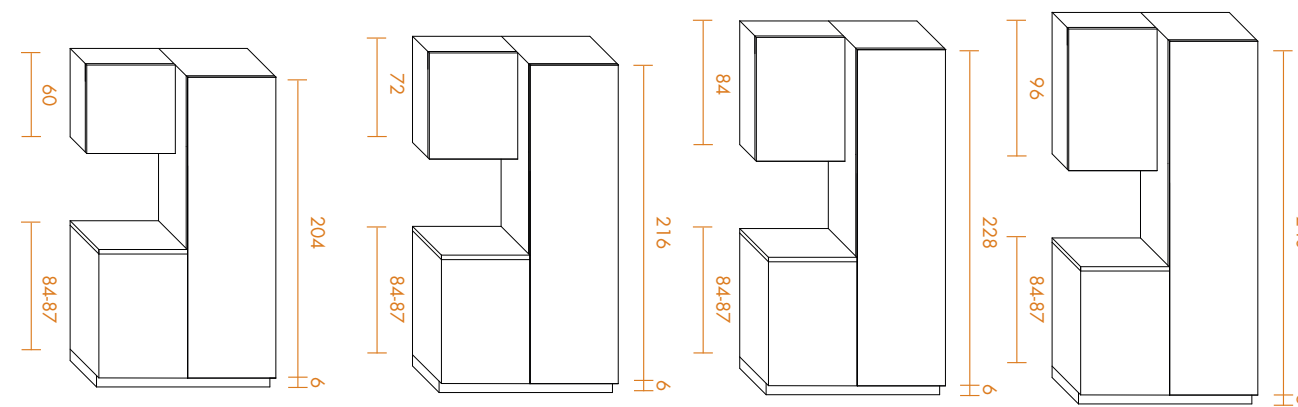

TIME
DISPONIBLE
EN STOCK



FINITIONS FAÇADES | ACABADOS PUERTAS

MÉLAMINÉ | MELAMINICO

STRUCTURES
ESTRUCTURA

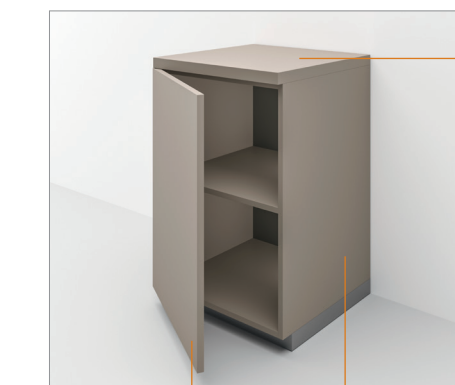
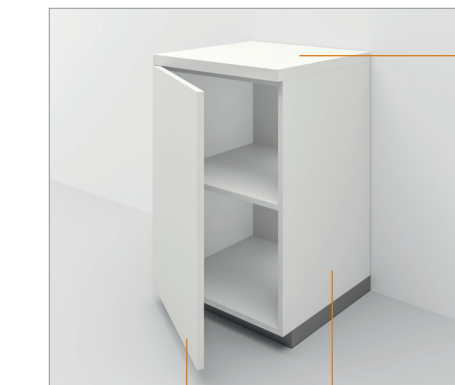

MÉLAMINÉ | MELAMINICO

FAÇADES TEINTE UNIE
PUERTAS COLOR SÓLIDO

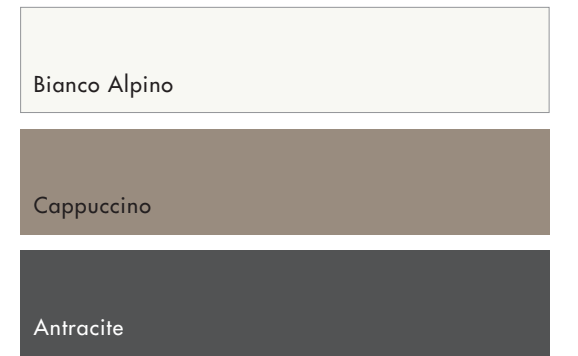

FAÇADES FINITIONS MATIÈRE
PUERTA ACABADO MATERICO



FAÇADES FINITION BOIS
PUERTAS ACABADOS MADERA



TOP STRATIFIÉ EN STOCK
EP. 20 et 40 mm - PROF. 600 et 800 mm

TOP LAMINADO EN STOCK
GR. 20 y 40 mm. - PROF. 600 y 800 mm.

TOP TEINTE UNIE
TOP COLOR SÓLIDO

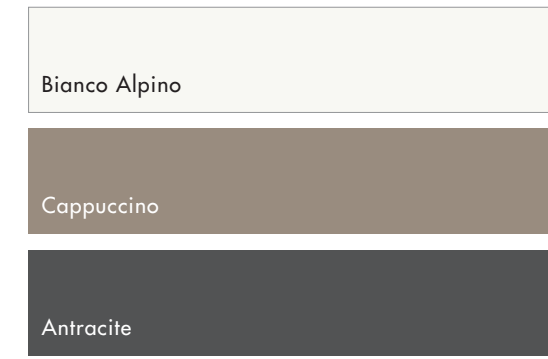

TOP FINITION BOIS
TOP ACABADOS MADERA

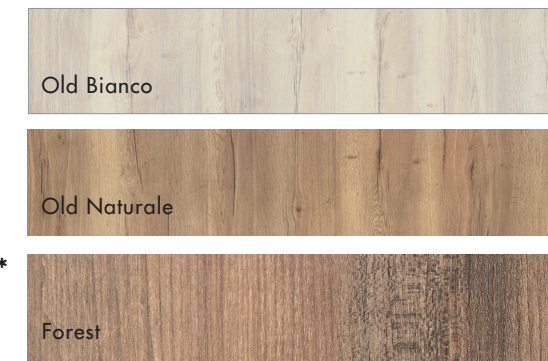

REHAUSSE PLATE ET TRIANGULAIRE
COPETE PLANA Y TRIANGULAR



TOP FINITIONS MATIÈRE
TOP ACABADO MATERICO



* seulement épaisseur 20mm
* solamente espesor 20 mm

POIGNÉES | TIRADORES

POIGNÉES INTÉGRÉES | TIRADORES INTEGRADOS

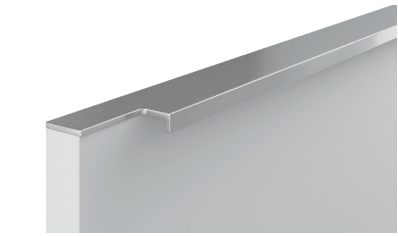

LINEA
10 entraxes variables
10 interejes variables

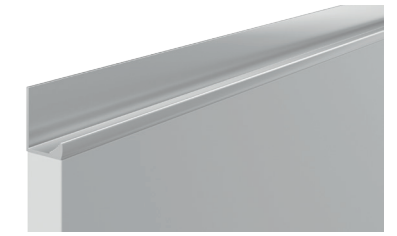

STEP
10 entraxes variables
10 interejes variables

POIGNÉES ENCASTRÉES | TIRADORES EMPOTRADOS

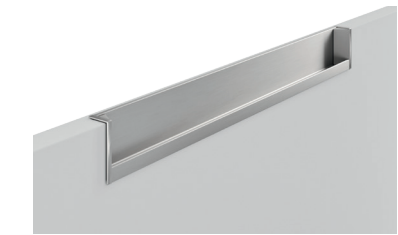

INCA
entraxe 96-160-320-640
horizontal et vertical
interrejes 96-160-320-640
horizontal y vertical



HOLE
10 entraxes variables,
horizontal et vertical
10 interrejes variables
horizontal y vertical



ALE
dimension 48-198.
Position poignée arrière porte
interrejes 48-198
posición tirador detrás la puerta

POIGNÉES | TIRADORES

POIGNÉES EXTERNES | TIRADORES EXTERNA



M08
entraxe | intereje 96-160-320



M93
entraxe | intereje 96-160-320-640



M03
entraxe | intereje
96-160-320-640

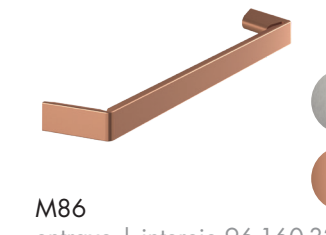

M86
entraxe | intereje 96-160-320



M85
entraxe | intereje 96-160-320

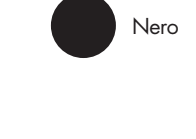

M14
entraxe | intereje 96-160-320



M09
entraxe | intereje
96-160-320-640-1920

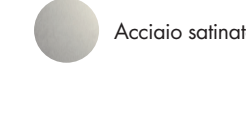

M78
entraxe | intereje 160



M01
entraxe | intereje 64-160-320

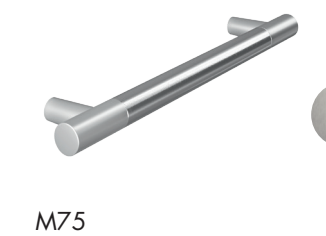

M75
entraxe | intereje 96-160-320-640

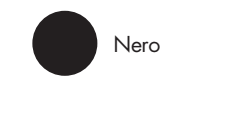
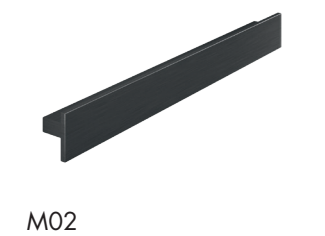

M02
entraxe | intereje 96-160-320-640-1920



M07
entraxe | intereje 160



M17
entraxe | intereje 16

GORGES | GOLAS

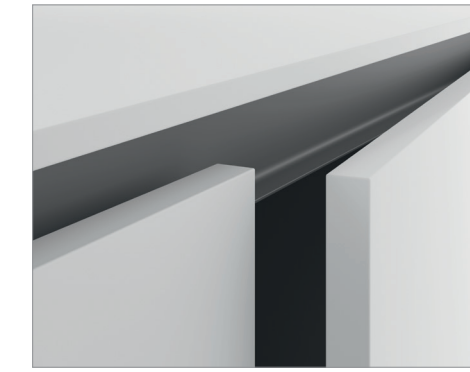

GORGE TRENDY
GOLA TRENDY

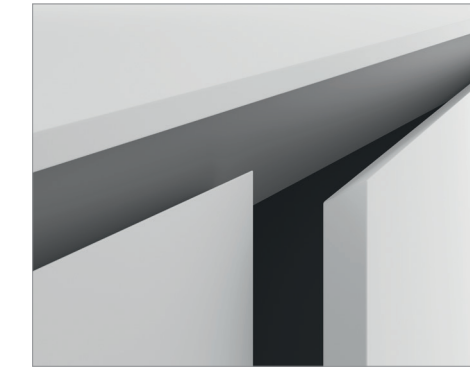

GORGE FLAT
GOLA FLAT

FINITIONS GORGE TRENDY
ACABADOS GOLA TRENDY

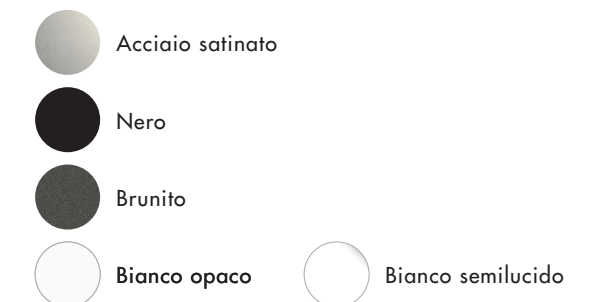

FINITIONS GORGE FLAT
ACABADOS GOLA FLAT

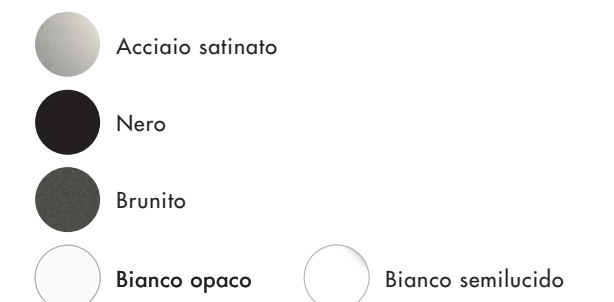

SOCLE | PATAS

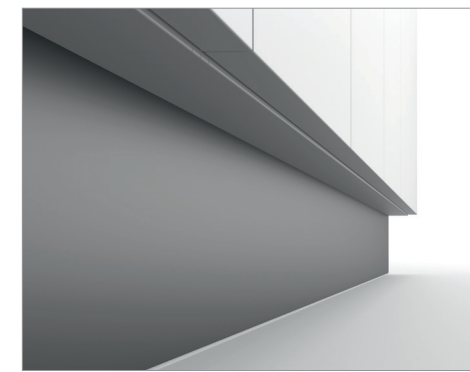

SOCLE PVC H12-15
ZOCALO DE PVC DE 12-15 DE ALTO

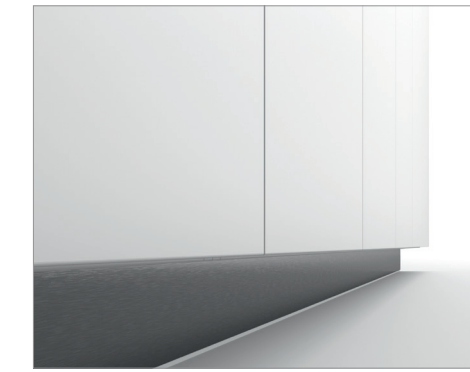

SOCLE ALUMINIUM H 6-12-15
ZOCALO DE ALUMINIO DE 6-12-15 DE ALTO

FINITIONS SOCLE PVC
ACABADOS PATA PVC

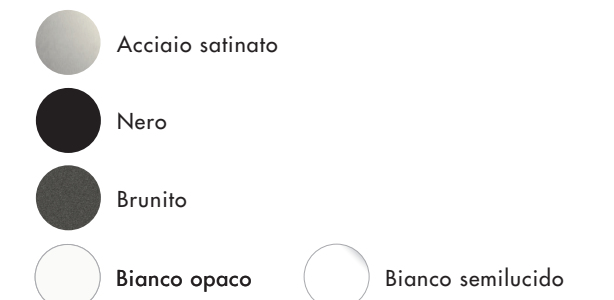

FINITIONS SOCLE ALUMINIUM
ACABADOS PATA ALUMINIUM

